

QUESTÃO 01

Circule a alternativa que completa o desenho:



QUESTÃO 02

Circule a alternativa correta:

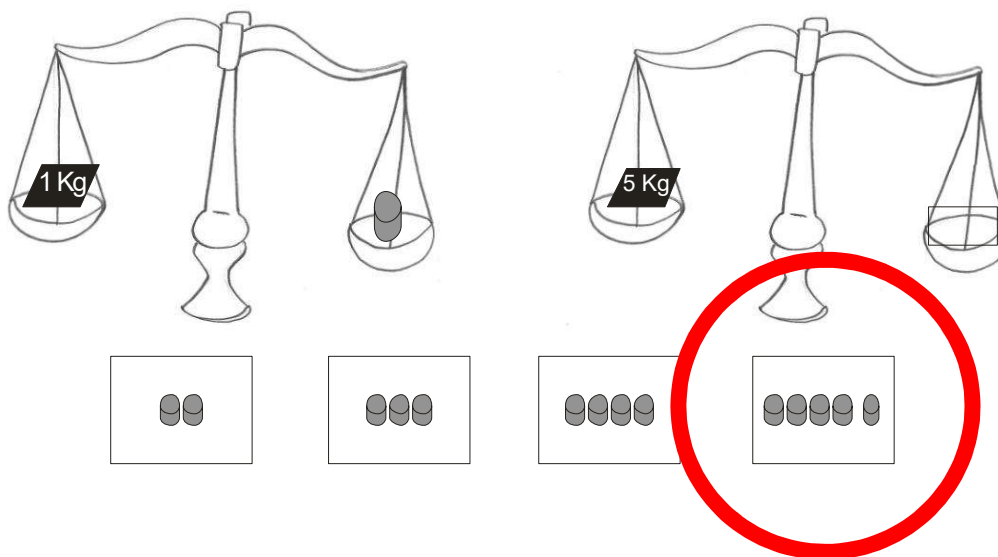

QUESTÃO 03

De acordo com o ambiente onde vive, circule a figura diferente:

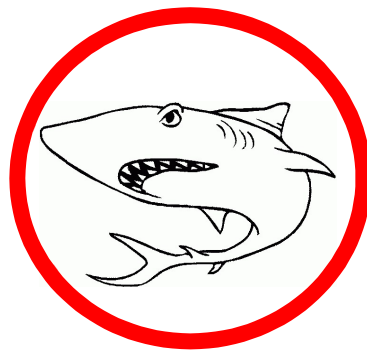
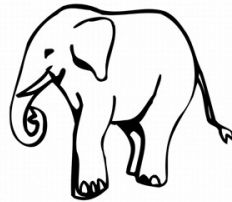

QUESTÃO 04

Circule a figura que não pertence à coleção:

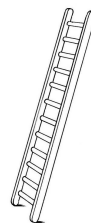

QUESTÃO 05

Circule a figura que não pertence à coleção:

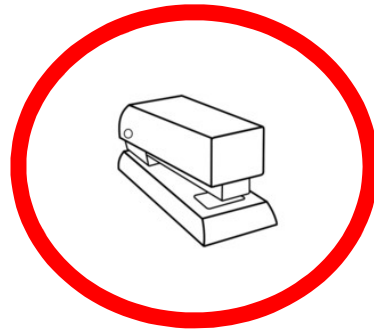
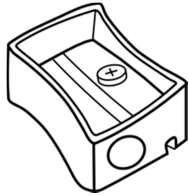

QUESTÃO 06

Circule a figura que não pertence à coleção:

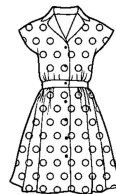

QUESTÃO 07

Circule a opção que corresponde a sequencia correta:

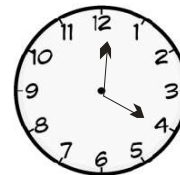
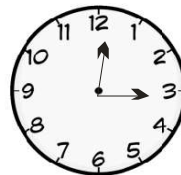
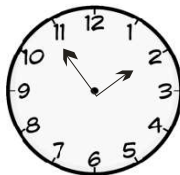
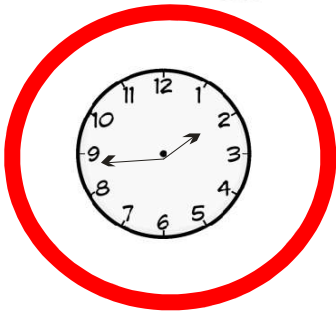
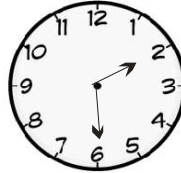
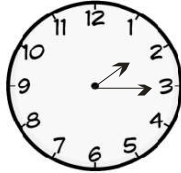
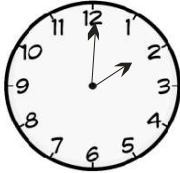

QUESTÃO 08

Circule a opção que corresponde a sequência correta:

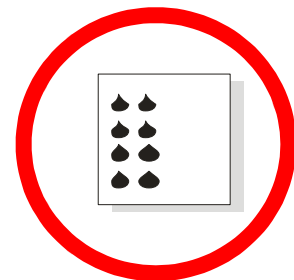
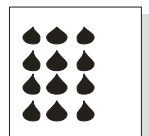
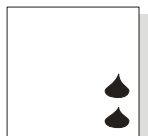
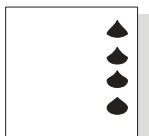
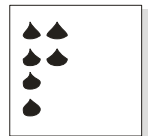
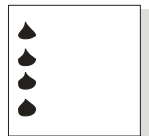

QUESTÃO 09

Circule a opção que corresponde a sequência correta:

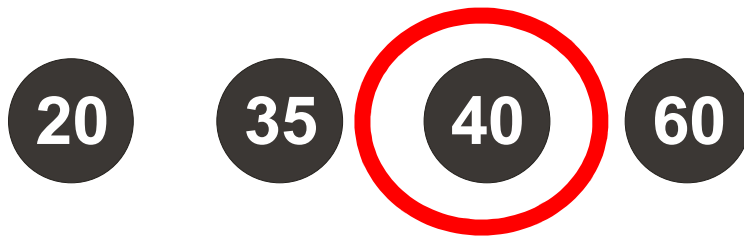
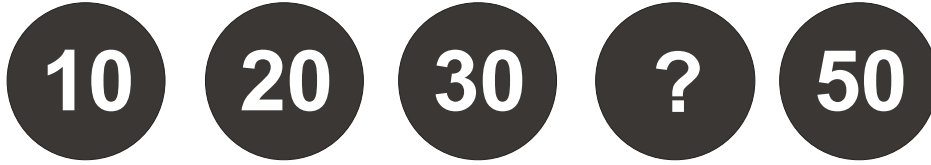

QUESTÃO 10

Circule a opção que corresponde a sequência correta:

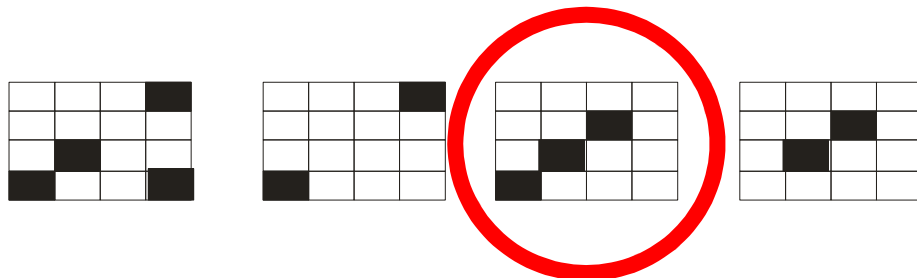
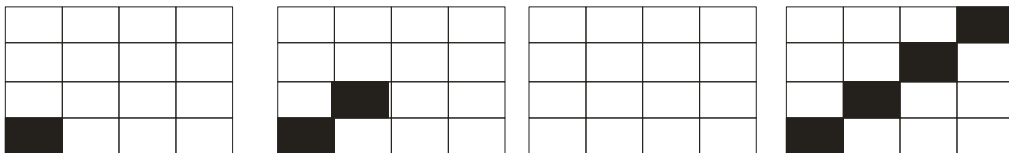

QUESTÃO 11

Circule a opção que corresponde a sequência correta:

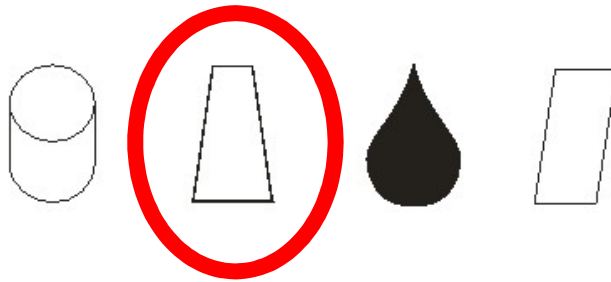
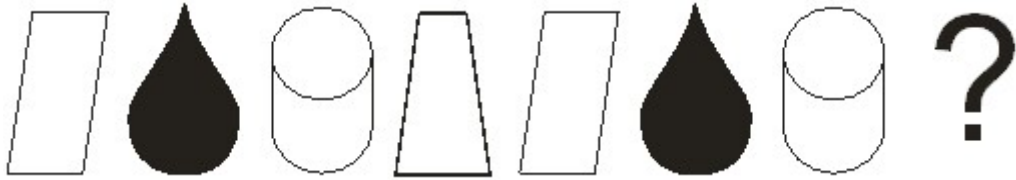

QUESTÃO 12

Circule e a opção que corresponde a sequência correta:

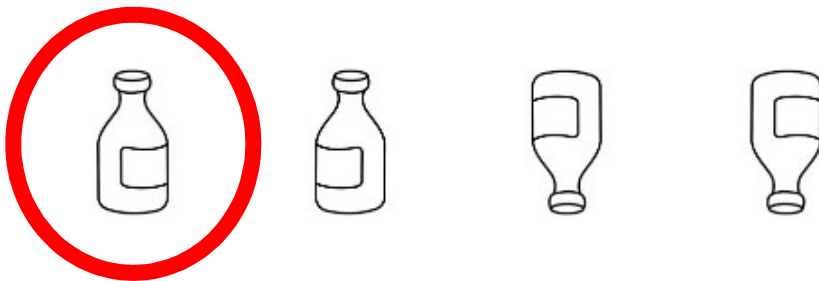

QUESTÃO 13

Circule a opção que completa o desenho:

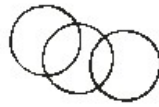
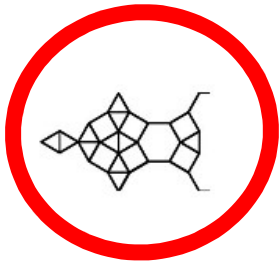
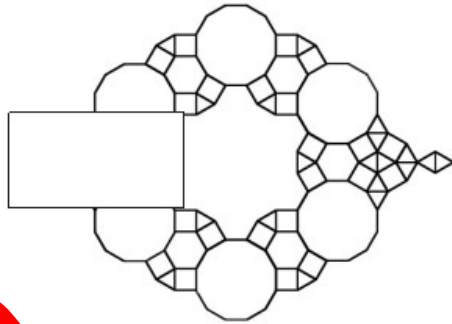

QUESTÃO 14

Circule a opção que completa o desenho:

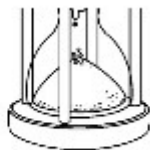
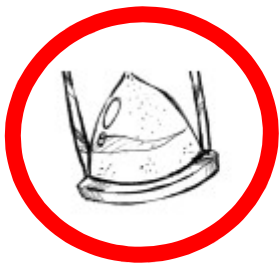

QUESTÃO 15

Circule a opção que completa o desenho:

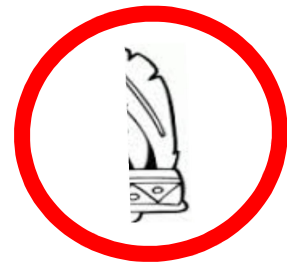
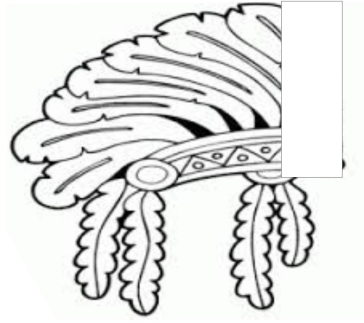

QUESTÃO 16

Circule a figura diferente no tamanho:

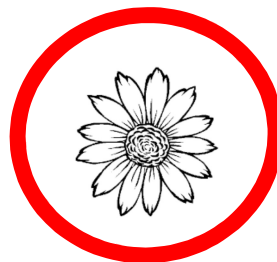

QUESTÃO 17

Circule a sequência correta:

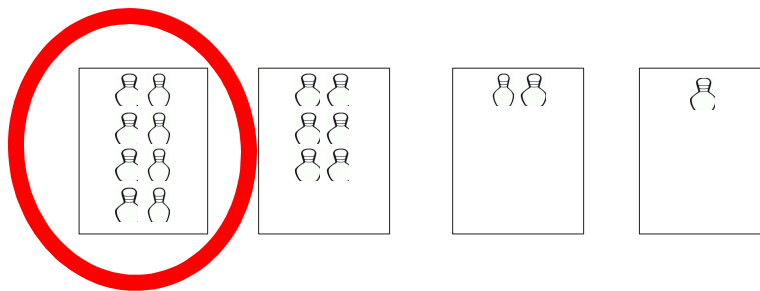
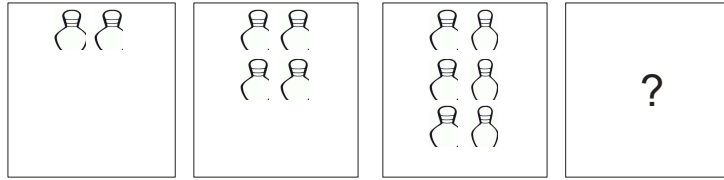

QUESTÃO 18

Circule a figura mais parecida com o desenho abaixo:

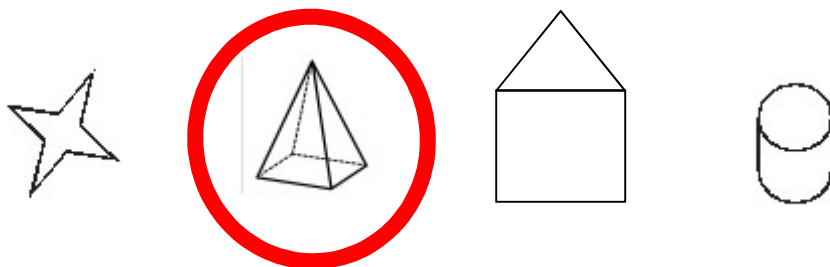
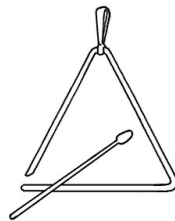

QUESTÃO 19

Circule a figura mais parecida com o desenho abaixo:



ANULADA

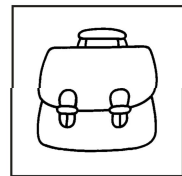
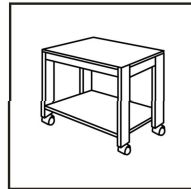
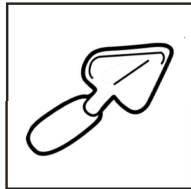
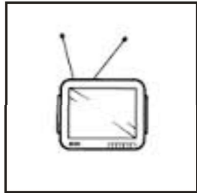

QUESTÃO 20

Circule a figura mais parecida com o desenho abaixo:\



ANULADA

